

Type F Cake Donut Depositor

\*Plunger, cylinder, and column mounting system are purchased separately

## TYPE F CAKE DONUT DEPOSITOR

Designed for quality cake donuts. Also makes excellent hushpuppies, loukoumades, falafel, ball-shaped fritters, and more, depending on the mix or recipe used.

### Description

- Belshaw depositors, the industry standard for many years, are legendary for their precision and smoothness of operation - even after years of use. Each depositor is engineered to produce identical volume and shape with every deposit.
- An adjustment dial allows you to adjust the amount of batter for each deposit. The Type F Depositor utilizes a motor and trigger handle to deposit at a rate up to 115 per minute. The faster stroke rate and easier operation of the Type F reduces frying time variability between the first and last deposits into the fryer and is physically easier on the operator. A half-speed version of the Type F, which deposits up to 57 times per minute, is also available.

### Features

- Aluminum alloy frame
- Hardened steel cams
- Bronze trip arms and bushings
- Batter volume adjustment dial
- Aluminum hopper (Capacity 15 lbs/6.8 kg)

- Heavy duty motor - Totally enclosed, fan-cooled, with 5 amp thermally protected circuit breaker
- Hand trigger control up to 115 cycles/minute
- Compatible with Belshaw Type B/Type F plungers and cylinders only
- Half-speed option, deposits a maximum rate of 57 deposits/minute instead of 115/minute. (sometimes referred to as 'Single Lead')

### New Hopper Divider Accessory

- Simple, effective accessory for making 2-color/2-flavor cake donuts (Part # 0290-1000). Divides hopper into two and accepts two separate mixes.

### Mounting Systems

- Type B/F Column Mount (#0405)
- Wall Mount (#0406)
- Bracket Arm Height Adjuster (#0400) for faster more precise height adjustments (A set collar is provided as standard equipment).

### Plungers and Cylinders

- Plungers are available for rings, sticks, old fashions, crullers, kinkles and more.
- Plungers and cylinders are purchased separately. See Belshaw's 'Plunger Guide for Cake Donuts' or [www.belshaw.com/products/category/plungers-and-accessories](http://www.belshaw.com/products/category/plungers-and-accessories).

### Shipping data

- Depositor (w/mount arms, if ordered):  
19" x 21" x 26", 75 lbs (48 x 53 x 66 cm, 34 kg)
- Column for mounting system (if ordered):  
49" x 2" x 2", 14 lbs (36 x 5 x 5 cm, 7 kg)
- Freight class: 85

### Electrical options

- 120 Volts, 60 Hertz, 1-phase, 200W, 2 Amps
- 208-240 Volts, 50/60 Hertz, 1-phase, 200W, 1.5–2 Amps

### Certifications

- Certified to UL-763, NSF-169, CSA C22.2
- CE models available

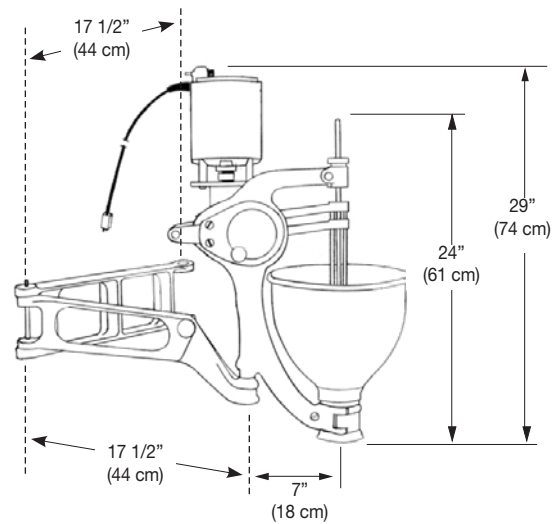



















### ACCESSORIES AND REPLACEMENT ITEMS

Item Nbr.	Description	Description
0405	F COLUMN MOUNTING KIT	Column mount bracket kit for Type B or Type F
0406	WALL MT BRKT KIT	Wall mount bracket kit, Type B or Type F
0400	HEIGHT ADJ KIT	Bracket Arm Height Adjuster. Enables quick accurate adjustment to height of depositor. (For column mount only)
0290	HOPPER ASSY LG BORE	Hopper for Type B or Type F

### PLUNGERS AND CYLINDERS

Item Nbr.	Description
Plungers and cylinders are purchased separately. See Belshaw's "Plunger Guide for Cake Donuts" or <a href="http://www.belshaw.com/products/category/plungers-and-accessories">www.belshaw.com/products/category/plungers-and-accessories</a>	
Each plunger must match a cylinder of the same size. Different plungers may be used with just one cylinder, provided all are the same size. For instance, a 1-3/4" plunger can only be used with a 1-3/4" cylinder.	
0035SSAx[size]	Cylinder for sizes up to 1-3/4" [insert size in inches]. Example: 0035SSAx1-3/4
0035SSBx[size]	Cylinder for sizes 1-7/8" and larger [insert size in inches]. Example: 0035SSBx2

- Standard plunger sizes are 1-1/2" to 2" in diameter.
- Larger and smaller sizes can be made to order – contact parts@belshaw.com for price and availability.
- **Each plunger must be used with a cylinder of the same size.** For cylinder item numbers, see the bottom of the table below.

Plunger	Item Numbers	Description	Photo	Donut type
● <b>Plain</b>	7SS x1-1/2 7SS x1-5/8 7SS x1-3/4 7SS x1-7/8 7SS x2	For plain ring donuts (using standard cake donut mix); for 'Old Fashion' donuts (using Old Fashion mix).		
● <b>Star</b>	7SC-SS x1-1/2 7SC-SS x1-5/8 7SC-SS x1-3/4 7SC-SS x1-7/8 7SC-SS x2	For a ring donut with a more consistent, rounder hole than the plain plunger, with a star pattern around it.		
● <b>French Cruller</b>	7B-1009 x1-1/2 7B-1009 x1-5/8 7B-1009 x1-3/4 7B-1009 x1-7/8 7B-1009 x2	Use with French Cruller mix to make French Crullers. Use with standard cake donut mix to make 'French Cake' donuts that look similar, but without the eggy flavor and texture.		
● <b>Krinkle</b>	7F-1004 x1-1/2 7F-1004 x1-5/8 7F-1004 x1-3/4 7F-1004 x1-7/8 7F-1004 x2	Features eight distinctive ball shaped sections all joined together like a necklace. Sometimes known as Pon-de-Ring.		
● <b>Ball</b> Deposits up to 5 round donuts (or 'donut holes').	7G-1000-[code] <i>Call Belshaw to select size and obtain correct code. Must specify number and diameter of holes.</i>	Produces ball shaped donuts or 'donut holes'. With a compatible mix recipe, can also make other products such as hushpuppies, loukoumades, falafel, fish balls, and more.		
● <b>Loukoumades</b>	7G-1000-103C	The standard Loukoumades plunger, makes 3 per plunger stroke. 2" diameter, with 3 x 3/4" round holes		
● <b>Hushpuppy</b>	7G-1000-103DB	The standard Hushpuppy plunger, makes 3 per plunger stroke. 2" diameter, with 3 oval holes, each hole 7/8" by 1" across		
● <b>Stick</b> Deposits 1 or 2 stick donuts.	7H-1000-[code] (makes 1) 7H-1001-[code] (makes 2) <i>Call Belshaw to select size and obtain correct code. Must specify number and diameter of holes.</i>	Makes 1 or 2 stick donuts. The thickness of the donut will depend on the size of the slot and the length will depend on the dial setting of the depositor. (Setting 1 will be short, setting 2 or 3 will be longer)		
● <b>Churro</b>	7CD-1009X2 (Single size)	For churros 2 to 6 inches long .		
Cylinder	Item Numbers	Description	Photo	Donut type
● <b>Cylinders</b>	035SSA x1-1/2 035SSA x1-5/8 035SSA x1-3/4 035SSB x1-7/8 035SSB x2	Plunger size and cylinder size must match. For example, a 1-3/4" plunger must always be used with a 1-3/4" cylinder. You can use multiple plungers with a single cylinder, if they are the same size.		ALL TYPES

## ACCESSORIES FOR TYPE B AND TYPE F CAKE DONUT DEPOSITORS



### Column Mount Bracket Kit

- The Column Mount supports Type B, F and F-YRD depositors. The column is usually mounted on the left side of a Belshaw Adamatic fryer. For mounting on the right, the Bracket Plate can be moved from the left to the right side. Fryer must be bolted to the floor. The full extension of the column mount is 42"/105cm, from the column to the actual donut drop.

**Item Nbr #0405 (for Type B and Type F),  
Item Nbr #P-1000 (Bracket Plate Kit, for non-Belshaw  
fryers—purchased separately)**

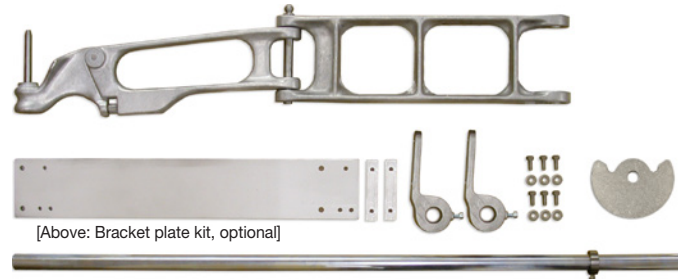

[Above: Bracket plate kit, optional]

### Wall Mount Bracket Kit

- Supports Type B or F cake donut depositors, with precision screw for adjusting the angle of the depositor. Mounts to the wall behind or alongside fryer. Maximum extension 42"/105cm from wall to donut drop.

**Item Nbr #0406**

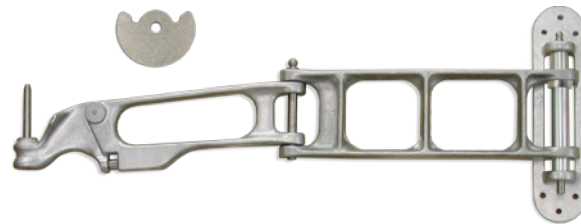

### Bracket Arm Height Adjuster

- The Bracket Arm Height Adjuster precisely adjusts the height of your Type B, F or N cake donut depositor. The large turn screw adjustment is faster and more accurate than the Set Collar supplied with the standard mounting kits. Useful when making more than one type of cake donut. For column mount only.

**Item Nbr #0400**

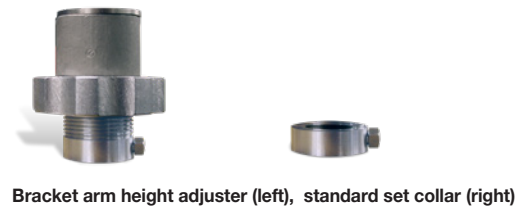

Bracket arm height adjuster (left), standard set collar (right)

### Hopper

- Replacement aluminum hopper for Type B and Type F. Capacity 15 lbs (6.8 kg). Accepts Belshaw Cylinders into bottom opening. (Supplied standard with standard Type B and Type F machines)

**Item Nbr #0290**



Hopper

### Plungers and Cylinders

- A variety of plungers and cylinders are available for Type B and F depositors. (See following page for details)



Plungers and cylinders