

AREMDE COFFEE FUTURE REMADE

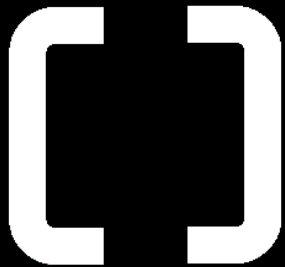

STYLUS ONE
IMAGINATION
NOT INCLUDED



WWW.AREMDE.COM.AU

@AREMDEOFFICIAL

INFO@AREMDE.COM.AU

AREMDE

UNLEASHING THE POWER OF CREATIVITY

First, we introduced our breakthrough coffee machine, NEXUS One as the Theatre of Skills for all professional coffee masters of the world. Now we proudly present STYLUS One, the first fully customisable coffee machine the industry has ever seen: a true Canvas of Creativity. With all the tech specs and services you can expect from AREMDE.

The only thing we do not provide is that one special feature: your own imagination. Combine it with the unlimited customisation possibilities of STYLUS One and have your coffee future remade.

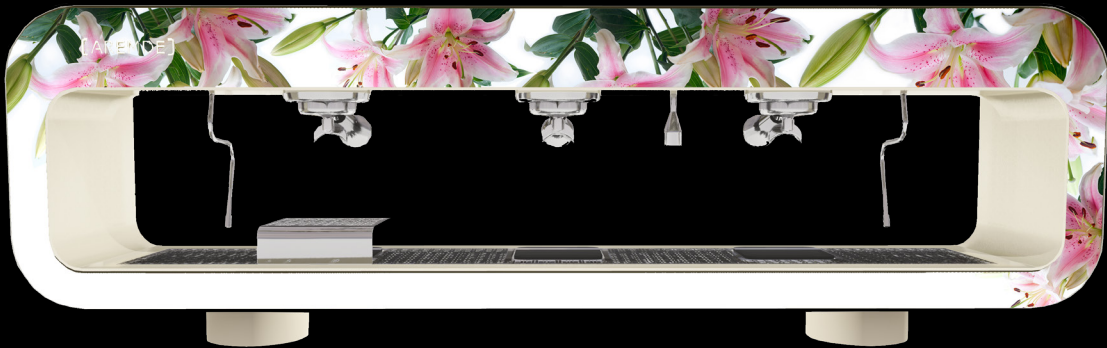

STYLE IT

WITH PICTURES,
TEXTURES, COLOURS AND
LOGO'S TO BOOST YOUR
BUSINESS IDENTITY TO THE MAX



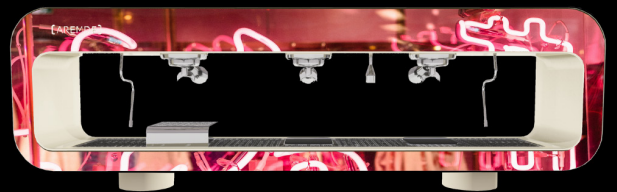
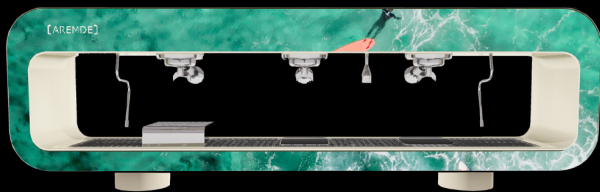
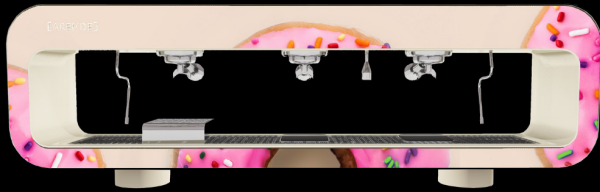

STYLUS ONE

THE CANVAS OF CREATIVITY

User centered

Everything is designed with customer experience in mind: the handle allows for easier and stronger grip, the chassis curvature ensures the group is within the Coffee Master line of sight, the machine's low profile design allows for interaction with the audience.

Easy Touch

The buttons are designed to be simple and smart: short touch purges, longer touch latches until pressed again, freeing the Coffee Master's hand to perform.



Steam Control

Hot steam preserves while cooler steam is circulated back to boiler.

Smart Hot

The desired hot water temp is achieved using a cold water tempering valve after the boiler to get the temperature desired fast while maintaining boiler efficiency.



Function Display

Change group temp volume and visual settings.

Fully Customisable

Customisable panels and personalised body material and colour.

LED Spotlight

Since everything is about what is going to be in the cup, we ensured it stands out using LED spot lights to complement the experience.

Perfect Consistency

The technology integrated to the group head ensures temperature fluctuation is less than 0.2C. This ensures the perfect coffee extraction everytime.

Safe Steam

The lever is thermally insulated to be safe for the Coffee Master to operate and clean.

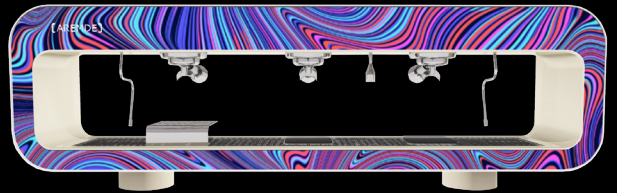

STYLUS ONE

CUSTOMISE IT
BACK TO FRONT

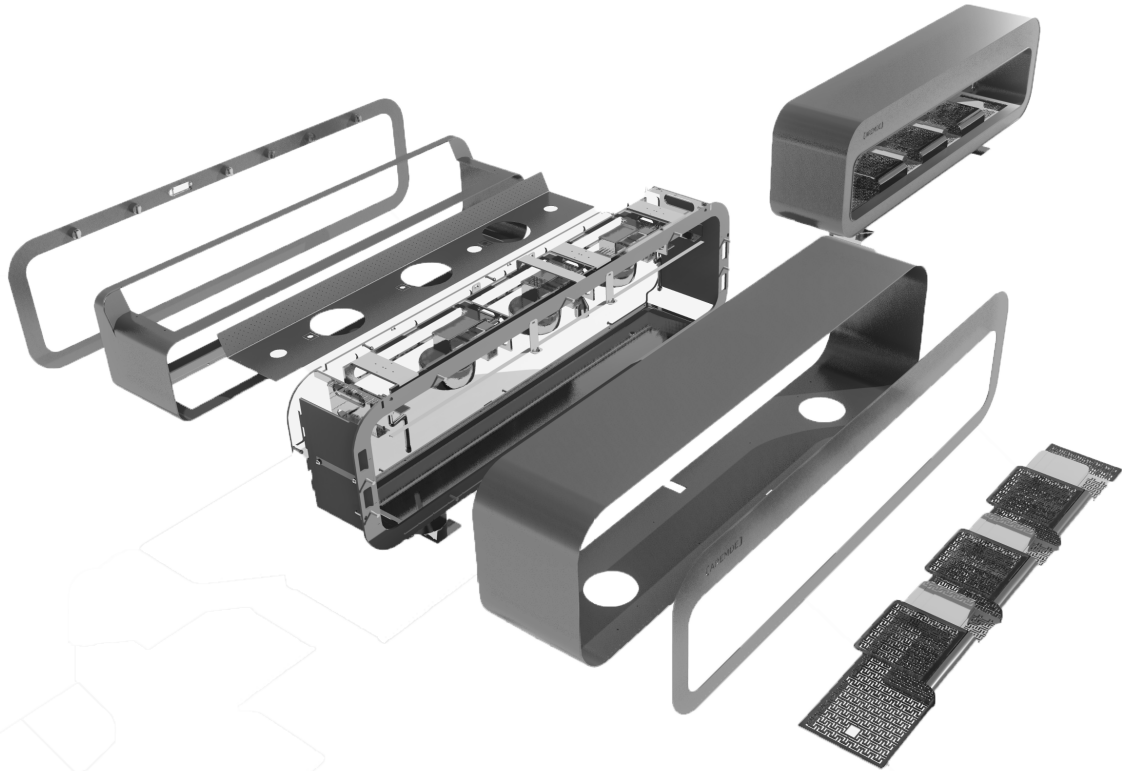

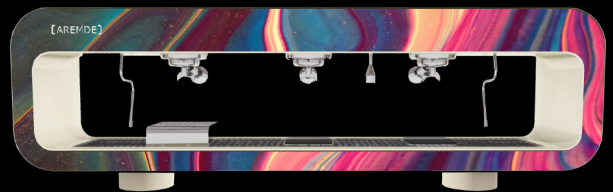

STYLUS ONE

TECH SPECS

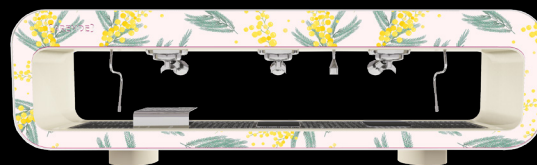

UNITS/ VERSION	2Group - 2 Steam -1 Hot Water	3Group - 2Steam - 1Hot Water
BODY	Stainless Steel - 304/316 - Coated Removable front and back panels	
BOILER	14 Litre Steam - 1 Litre Coffee (per group)	17 Litre Steam - 1 Litre Coffee (per group)
HYDRAULICS	Digital - adjustable steam and coffee temperatures made with Copper, Brass and Stainless.	
GROUP	2 x Brass/Stainless - Composite	3 x Brass/Stainless - Composite
STEAM	Dedicated Boiler Copper - Stainless Steel - 1.2 or 1.5mm supplied	
HOT WATER	Built in Economiser Electronic Dosage	
CUP WARMER	Optional Accessory - stand alone	
ELECTRONICS	PID controlled heating, Micro-computer PCB (programmable)	
DOSAGE SYSTEM	Volumetric or Extraction Weight Based (Wexus)	
POWER	5200w/7300w (Steam 4500w, Coffee 1300w per group, Pump 180w)	10100w/9700w (Steam 5200w, Coffee 1300w per group, Pump 180w)
VOLTAGE	220-240VAC 50/60Hz - (240VAC - 32AMP)	220-240VAC 50/60Hz - (240VAC - 40AMP)
DIMENSIONS CTU* UCU** A-Hydra UCU-B-Elec	L: 925 (36 7/16"), D: 230 (9"), H: 405 (15 15/16") L: 710 (27 15/16"), D: 346 (16 9/16"), H: 512 (20 3/16") L: 604 (23 14/16"), D: 346 (16 9/16"), H: 142 (5 9/16")	L: 1200 (48 11/16"), D: 230 (9"), H: 405 (15 15/16") L: 860 (33 14/16"), D: 346 (16 9/16"), H: 512 (20 3/16") L: 604 (23 14/16"), D: 346 (16 9/16"), H: 142 (5 9/16")
WEIGHT	95kg (CTU 40kg, UCU Electrical 15kg, UCU 40kg)	110kg (CTU 50kg, UCU Electrical 15kg, UCU 45kg)